

SIT timing pulleys - METRIC PITCH

Standard timing pulleys METRIC PITCH are made in aluminum, in solid hub execution.

Solid hub

Material: aluminum

Pitch:

- T 2,5
- T 5
- T 10

- AT5
- AT 10



Solid hub

Material: on request

Pitch:

- T20

- AT 20



Special executions

Upon request, SIT is able to design and manufacture any type of pulley based on customer requirements.

For standard executions the teeth shape and the consequent backlash are related to the number of teeth.

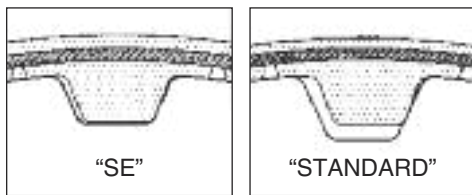

Z < 20

Z > 20

SE: reduced backlash

On demand, in case of very precise applications (e.g. positioning systems), a "zero backlash" version can be supplied.



On demand

TOLERANCES

Pulley diameter tolerances

External diameter [mm]	Tolerances [mm]
up to 25,4	-0,05 +0,00
from 25,5 to 50,8	-0,08 +0,00
from 50,9 to 102	-0,10 +0,00
from 103 to 178	-0,13 +0,00
from 179 to 305	-0,15 +0,00
from 306 to 509	-0,18 +0,00
from 510 to 761	-0,20 +0,00
from 762 to 1015	-0,23 +0,00
more than 1016	-0,25 +0,00

Radial circular runout

External diameter [mm]	Measured total eccentricity [mm]
up to 203,2	0,13
more than 203,2	add 0,013 for any 25,4 of diameter

Cylindricity tolerance

Pulley width	Tolerances
for any 100 mm	0,1 mm without exceeding the external diameter tolerance

Flanged pulleys

Timing belts, when in motion, have a slight lateral displacement. It is therefore necessary to use at least one flanged pulley to prevent the belt jumping out of the pulley.

Usually, in order to reduce the costs, the flanged pulley is the one with the smaller diameter.

In any case, when the distance of the axes is greater than 8 times the diameter of the small pulley, or when the transmission is working on shafts arranged in a position that is not horizontal, both pulleys have to be flanged.

Protective coating

Lifetime of aluminum pulleys can be reduced because the nylon coating of the belt teeth has a slightly abrasive effect.

This disadvantage can be reduced applying a high thickness anodization coating on the pulley teeth.

Note

Due to a constant improvement of our products, technical data of the pulleys may be subject to changes.

For technical and production reasons, in some cases materials other than those indicated in the catalogue may be used.

For confirmation of the material actually available, please contact customer service.

Dimensions of timing pulleys METRIC PITCH "T" - solid hub

Pitches T 2,5 - T 5 - T 10 - T 20



Part Number	PDMT 27 T2,5 /24
METRIC PITCH timing pulley "T"	
Total width (mm)	
Pitch	
Number of teeth	

T 2,5

Code	Teeth nr.	Type	E [mm]	R [mm]	S [mm]	H [mm]	W [mm]	Y [mm]	Z [mm]	Material
PDMT 16 T2,5/12	12	2	13,0	9,55	9,05	13,0	9,0	16,0	7,0	aluminum
PDMT 16 T2,5/14	14	2	15,0	11,14	10,64	15,0	9,0	16,0	7,0	
PDMT 16 T2,5/15	15	2	15,0	11,94	11,44	15,0	9,0	16,0	7,0	
PDMT 16 T2,5/16	16	2	16,0	12,73	12,23	16,0	10,0	16,0	6,0	
PDMT 16 T2,5/18	18	1	17,5	14,32	13,82	10,0	10,0	16,0	6,0	
PDMT 16 T2,5/19	19	1	20,0	15,12	14,62	10,0	10,0	16,0	6,0	
PDMT 16 T2,5/20	20	1	20,0	15,92	15,41	11,0	10,0	16,0	6,0	
PDMT 16 T2,5/22	22	1	22,0	17,51	17,01	11,0	10,0	16,0	6,0	
PDMT 16 T2,5/24	24	1	22,0	19,10	18,60	12,0	10,0	16,0	6,0	
PDMT 16 T2,5/25	25	1	23,0	19,89	19,39	13,0	10,0	16,0	6,0	
PDMT 16 T2,5/26	26	1	26,0	20,69	20,19	14,0	10,0	16,0	6,0	
PDMT 16 T2,5/28	28	1	26,0	22,28	21,78	14,0	10,0	16,0	6,0	
PDMT 16 T2,5/30	30	1	28,0	23,87	23,37	16,0	10,0	16,0	6,0	
PDMT 16 T2,5/32	32	1	32,0	25,46	24,96	16,0	10,0	16,0	6,0	
PDMT 16 T2,5/36	36	1	36,0	28,65	28,15	20,0	10,0	16,0	6,0	
PDMT 16 T2,5/40	40	1	38,0	31,83	31,33	22,0	10,0	16,0	6,0	
PDMT 16 T2,5/44	44	1	42,0	35,01	34,51	24,0	10,0	16,0	6,0	
PDMT 16 T2,5/48	48	1A	-	38,20	37,70	26,0	10,0	16,0	6,0	
PDMT 16 T2,5/60	60	1A	-	47,75	47,25	34,0	10,0	16,0	6,0	

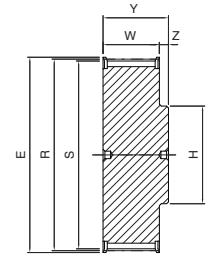

1

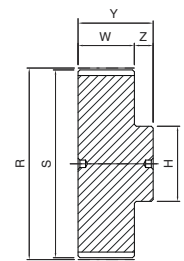

1A

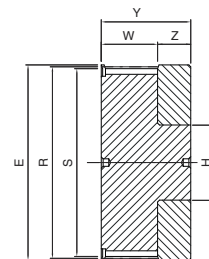

2

T 5

Code	Teeth nr.	Type	E [mm]	R [mm]	S [mm]	H [mm]	Belt width						Z [mm]	Material
							10 mm		16 mm		25 mm			
							W [mm]	Y [mm]	W [mm]	Y [mm]	W [mm]	Y [mm]		
PDMT quoteY T5/10	10	1	19,50	15,92	15,07	8,0	15,0	21,0	21,0	27,0	30,0	36,0	6,0	aluminum
PDMT quoteY T5/12	12	1	23,00	19,10	18,26	11,0	15,0	21,0	21,0	27,0	30,0	36,0	6,0	
PDMT quoteY T5/14	14	1	25,00	22,28	21,44	13,0	15,0	21,0	21,0	27,0	30,0	36,0	6,0	
PDMT quoteY T5/15	15	1	28,00	23,87	23,03	16,0	15,0	21,0	21,0	27,0	30,0	36,0	6,0	
PDMT quoteY T5/16	16	1	32,00	25,46	24,62	18,0	15,0	21,0	21,0	27,0	30,0	36,0	6,0	
PDMT quoteY T5/18	18	1	32,00	28,65	27,81	20,0	15,0	21,0	21,0	27,0	30,0	36,0	6,0	
PDMT quoteY T5/19	19	1	36,00	30,24	29,40	20,0	15,0	21,0	21,0	27,0	30,0	36,0	6,0	
PDMT quoteY T5/20	20	1	36,00	31,83	30,99	22,0	15,0	21,0	21,0	27,0	30,0	36,0	6,0	
PDMT quoteY T5/22	22	1	38,00	35,01	34,17	23,0	15,0	21,0	21,0	27,0	30,0	36,0	6,0	
PDMT quoteY T5/24	24	1	42,00	38,20	37,36	24,0	15,0	21,0	21,0	27,0	30,0	36,0	6,0	
PDMT quoteY T5/25	25	1	44,00	39,79	38,95	26,0	15,0	21,0	21,0	27,0	30,0	36,0	6,0	
PDMT quoteY T5/26	26	1	44,00	41,38	40,54	26,0	15,0	21,0	21,0	27,0	30,0	36,0	6,0	
PDMT quoteY T5/27	27	1	48,00	42,97	42,13	30,0	15,0	21,0	21,0	27,0	30,0	36,0	6,0	
PDMT quoteY T5/28	28	1	48,00	44,56	43,72	32,0	15,0	21,0	21,0	27,0	30,0	36,0	6,0	
PDMT quoteY T5/30	30	1	51,00	47,75	46,91	34,0	15,0	21,0	21,0	27,0	30,0	36,0	6,0	
PDMT quoteY T5/32	32	1	54,00	50,93	50,09	38,0	15,0	21,0	21,0	27,0	30,0	36,0	6,0	
PDMT quoteY T5/36	36	1	64,00	57,30	56,46	38,0	15,0	21,0	21,0	27,0	30,0	36,0	6,0	
PDMT quoteY T5/40	40	1	66,50	63,66	62,82	40,0	15,0	21,0	21,0	27,0	30,0	36,0	6,0	
PDMT quoteY T5/42	42	1	70,00	66,85	66,00	40,0	15,0	21,0	21,0	27,0	30,0	36,0	6,0	
PDMT quoteY T5/44	44	1A	-	70,03	69,19	45,0	15,0	21,0	21,0	27,0	30,0	36,0	6,0	
PDMT quoteY T5/48	48	1A	-	76,39	75,55	50,0	15,0	21,0	21,0	27,0	30,0	36,0	6,0	
PDMT quoteY T5/60	60	1A	-	95,49	94,65	65,0	15,0	21,0	21,0	27,0	30,0	36,0	6,0	

Dimensions of timing pulleys METRIC PITCH “T” - solid hub



T 10

Code	Teeth nr.	Type	E [mm]	R [mm]	S [mm]	U [mm]	H [mm]	Belt width								Z [mm]	Material
								16 mm		25 mm		32 mm		50 mm			
								W [mm]	Y [mm]	W [mm]	Y [mm]	W [mm]	Y [mm]	W [mm]	Y [mm]		
PDMT quoteY T10/12	12	1	42,0	38,20	36,34	-	28,0	21,0	31,0	30,0	40,0	-	-	-	-	10,0	aluminum
PDMT quoteY T10/14	14	1	48,0	44,56	42,70	-	32,0	21,0	31,0	30,0	40,0	-	-	-	-	10,0	
PDMT quoteY T10/15	15	1	51,0	47,75	45,89	-	32,0	21,0	31,0	30,0	40,0	-	-	-	-	10,0	
PDMT quoteY T10/16	16	1	54,0	50,93	49,07	-	35,0	21,0	31,0	30,0	40,0	-	-	-	-	10,0	
PDMT quoteY T10/18	18	1	60,0	57,30	55,44	-	40,0	21,0	31,0	30,0	40,0	37,0	47,0	56,0	66,0	10,0	
PDMT quoteY T10/19	19	1	66,0	60,48	58,62	-	44,0	21,0	31,0	30,0	40,0	37,0	47,0	56,0	66,0	10,0	
PDMT quoteY T10/20	20	1	66,0	63,66	61,80	-	46,0	21,0	31,0	30,0	40,0	37,0	47,0	56,0	66,0	10,0	
PDMT quoteY T10/22	22	1	75,0	70,03	68,17	-	52,0	21,0	31,0	30,0	40,0	37,0	47,0	56,0	66,0	10,0	
PDMT quoteY T10/24	24	1	83,0	76,39	74,53	-	58,0	21,0	31,0	30,0	40,0	37,0	47,0	56,0	66,0	10,0	
PDMT quoteY T10/25	25	1	83,0	79,58	77,72	-	60,0	21,0	31,0	30,0	40,0	37,0	47,0	56,0	66,0	10,0	
PDMT quoteY T10/26	26	1	87,0	82,76	80,90	-	60,0	21,0	31,0	30,0	40,0	37,0	47,0	56,0	66,0	10,0	
PDMT quoteY T10/27	27	1	91,0	85,94	84,08	-	60,0	21,0	31,0	30,0	40,0	37,0	47,0	56,0	66,0	10,0	
PDMT quoteY T10/28	28	1	93,0	89,13	87,27	-	60,0	21,0	31,0	30,0	40,0	37,0	47,0	56,0	66,0	10,0	
PDMT quoteY T10/30	30	1	97,0	95,49	93,63	-	60,0	21,0	31,0	30,0	40,0	37,0	47,0	56,0	66,0	10,0	
PDMT quoteY T10/32	32	1	106,0	101,86	100,00	-	65,0	21,0	31,0	30,0	40,0	37,0	47,0	56,0	66,0	10,0	
PDMT quoteY T10/36	36	1	119,0	114,59	112,73	-	70,0	21,0	31,0	30,0	40,0	37,0	47,0	56,0	66,0	10,0	
PDMT quoteY T10/40	40	1	131,0	127,32	125,46	-	80,0	21,0	31,0	30,0	40,0	37,0	47,0	56,0	66,0	10,0	
PDMT quoteY T10/44	44	3A	-	140,06	138,20	118,0	88,0	21,0	31,0	30,0	40,0	37,0	47,0	56,0	66,0	10,0	
PDMT quoteY T10/48	48	3A	-	152,79	150,93	130,0	95,0	21,0	31,0	30,0	40,0	37,0	47,0	56,0	66,0	10,0	
PDMT quoteY T10/60	60	3A	-	190,99	189,13	165,0	110,0	21,0	31,0	30,0	40,0	37,0	47,0	56,0	66,0	10,0	

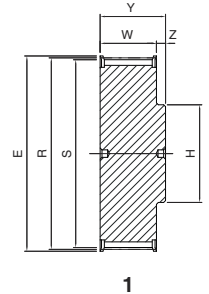

1

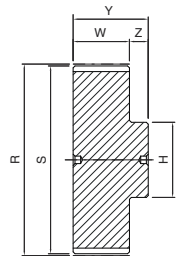

1A

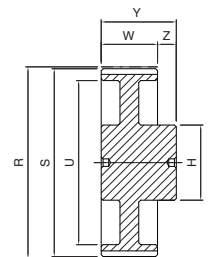

3A

T 20

Code	Teeth nr.	Type	E [mm]	R [mm]	S [mm]	U [mm]	H [mm]	d Ø	Belt width									Material
									32 mm			50 mm			100 mm			
									W [mm]	Y [mm]	Z [mm]	W [mm]	Y [mm]	Z [mm]	W [mm]	Y [mm]	Z [mm]	
PDMT quoteY T20/18	18	1	118,0	114,59	111,74	-	80,0	-	42,0	53,0	11,0	60,0	71,0	11,0	110,0	123,0	13,0	on request
PDMT quoteY T20/20	20	1	134,0	127,32	124,47	-	90,0	-	42,0	53,0	11,0	60,0	71,0	11,0	110,0	123,0	13,0	
PDMT quoteY T20/22	22	1	150,0	140,06	137,21	-	90,0	-	42,0	53,0	11,0	60,0	71,0	11,0	110,0	123,0	13,0	
PDMT quoteY T20/24	24	1	158,0	152,79	149,94	-	95,0	-	42,0	53,0	11,0	60,0	71,0	11,0	110,0	123,0	13,0	
PDMT quoteY T20/25	25	1	166,0	159,15	156,30	-	95,0	-	42,0	53,0	11,0	60,0	71,0	11,0	110,0	123,0	13,0	
PDMT quoteY T20/30	30	1	200,0	190,99	188,14	-	110,0	-	42,0	53,0	11,0	60,0	71,0	11,0	110,0	123,0	13,0	
PDMT quoteY T20/32	32	1A	-	203,72	200,87	-	110,0	-	42,0	53,0	11,0	60,0	71,0	11,0	110,0	123,0	13,0	
PDMT quoteY T20/36	36	1A	-	229,18	226,33	-	110,0	-	42,0	53,0	11,0	60,0	71,0	11,0	110,0	123,0	13,0	
PDMT quoteY T20/40	40	3A	-	254,65	251,80	210,0	110,0	-	42,0	53,0	11,0	60,0	71,0	11,0	110,0	123,0	13,0	
PDMT quoteY T20/48	48	3A	-	305,58	302,73	260,0	130,0	-	42,0	53,0	11,0	60,0	71,0	11,0	110,0	123,0	13,0	
PDMT quoteY T20/60	60	3A	-	381,97	379,12	338,0	130,0	22,0	42,0	53,0	11,0	60,0	71,0	11,0	110,0	123,0	13,0	
PDMT quoteY T20/72	72	3A	-	458,37	455,52	415,0	140,0	22,0	42,0	53,0	11,0	60,0	71,0	11,0	110,0	123,0	13,0	

Dimensions of timing pulleys METRIC PITCH “AT” - solid hub

Pitches AT 5 - AT 20



Part Number	PMAT 36 AT5 /20
METRIC PITCH timing pulley “AT”	
Total width (mm)	
Pitch	
Number of teeth	

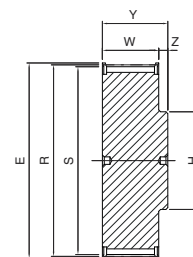

1

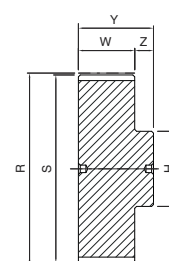

1A

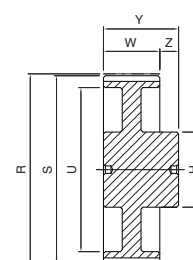

3A

AT 5

Code	Teeth nr.	Type	E [mm]	R [mm]	S [mm]	H [mm]	Belt width						Z [mm]	Material
							10 mm		16 mm		25 mm			
							W [mm]	Y [mm]	W [mm]	Y [mm]	W [mm]	Y [mm]		
PMAT quoteY AT5/12	12	1	23,0	19,10	17,88	11,0	15,0	21,0	21,0	27,0	30,0	36,0	6,0	aluminum
PMAT quoteY AT5/14	14	1	25,0	22,28	21,06	14,0	15,0	21,0	21,0	27,0	30,0	36,0	6,0	
PMAT quoteY AT5/15	15	1	28,0	23,87	22,65	16,0	15,0	21,0	21,0	27,0	30,0	36,0	6,0	
PMAT quoteY AT5/16	16	1	32,0	25,46	24,24	18,0	15,0	21,0	21,0	27,0	30,0	36,0	6,0	
PMAT quoteY AT5/18	18	1	32,0	28,65	27,43	20,0	15,0	21,0	21,0	27,0	30,0	36,0	6,0	
PMAT quoteY AT5/19	19	1	36,0	30,24	29,02	22,0	15,0	21,0	21,0	27,0	30,0	36,0	6,0	
PMAT quoteY AT5/20	20	1	36,0	31,83	30,61	23,0	15,0	21,0	21,0	27,0	30,0	36,0	6,0	
PMAT quoteY AT5/22	22	1	38,0	35,01	33,79	24,0	15,0	21,0	21,0	27,0	30,0	36,0	6,0	
PMAT quoteY AT5/24	24	1	42,0	38,20	36,98	26,0	15,0	21,0	21,0	27,0	30,0	36,0	6,0	
PMAT quoteY AT5/25	25	1	44,0	39,79	38,57	26,0	15,0	21,0	21,0	27,0	30,0	36,0	6,0	
PMAT quoteY AT5/26	26	1	44,0	41,38	40,16	26,0	15,0	21,0	21,0	27,0	30,0	36,0	6,0	
PMAT quoteY AT5/27	27	1	48,0	42,97	41,75	30,0	15,0	21,0	21,0	27,0	30,0	36,0	6,0	
PMAT quoteY AT5/28	28	1	48,0	44,56	43,34	32,0	15,0	21,0	21,0	27,0	30,0	36,0	6,0	
PMAT quoteY AT5/30	30	1	51,0	47,75	46,53	34,0	15,0	21,0	21,0	27,0	30,0	36,0	6,0	
PMAT quoteY AT5/32	32	1	54,0	50,93	49,71	36,0	15,0	21,0	21,0	27,0	30,0	36,0	6,0	
PMAT quoteY AT5/36	36	1	64,0	57,30	56,08	38,0	15,0	21,0	21,0	27,0	30,0	36,0	6,0	
PMAT quoteY AT5/40	40	1	67,0	63,66	62,44	40,0	15,0	21,0	21,0	27,0	30,0	36,0	6,0	
PMAT quoteY AT5/42	42	1	70,0	66,85	65,62	40,0	15,0	21,0	21,0	27,0	30,0	36,0	6,0	
PMAT quoteY AT5/44	44	1A	-	70,03	68,81	45,0	15,0	21,0	21,0	27,0	30,0	36,0	6,0	
PMAT quoteY AT5/48	48	1A	-	76,39	75,17	50,0	15,0	21,0	21,0	27,0	30,0	36,0	6,0	
PMAT quoteY AT5/60	60	1A	-	95,49	94,27	65,0	15,0	21,0	21,0	27,0	30,0	36,0	6,0	

AT 10

Code	Teeth nr.	Type	E [mm]	R [mm]	S [mm]	U [mm]	H [mm]	Belt width								Z [mm]	Material
								16 mm		25 mm		32 mm		50 mm			
								W [mm]	Y [mm]	W [mm]	Y [mm]	W [mm]	Y [mm]	W [mm]	Y [mm]		
PMAT quoteY AT10/15	15	1	51,0	47,75	45,93	-	31,0	21,0	31,0	30,0	40,0	-	-	-	-	10,0	aluminum
PMAT quoteY AT10/16	16	1	54,0	50,93	49,11	-	35,0	21,0	31,0	30,0	40,0	-	-	-	-	10,0	
PMAT quoteY AT10/18	18	1	60,0	57,3	55,48	-	40,0	21,0	31,0	30,0	40,0	37,0	47,0	56,0	66,0	10,0	
PMAT quoteY AT10/19	19	1	66,0	60,48	58,66	-	44,0	21,0	31,0	30,0	40,0	37,0	47,0	56,0	66,0	10,0	
PMAT quoteY AT10/20	20	1	66,0	63,66	61,84	-	46,0	21,0	31,0	30,0	40,0	37,0	47,0	56,0	66,0	10,0	
PMAT quoteY AT10/22	22	1	75,0	70,03	68,21	-	52,0	21,0	31,0	30,0	40,0	37,0	47,0	56,0	66,0	10,0	
PMAT quoteY AT10/24	24	1	83,0	76,39	74,57	-	58,0	21,0	31,0	30,0	40,0	37,0	47,0	56,0	66,0	10,0	
PMAT quoteY AT10/25	25	1	83,0	79,58	77,76	-	60,0	21,0	31,0	30,0	40,0	37,0	47,0	56,0	66,0	10,0	
PMAT quoteY AT10/26	26	1	87,0	82,76	80,94	-	60,0	21,0	31,0	30,0	40,0	37,0	47,0	56,0	66,0	10,0	
PMAT quoteY AT10/27	27	1	91,0	85,94	84,12	-	60,0	21,0	31,0	30,0	40,0	37,0	47,0	56,0	66,0	10,0	
PMAT quoteY AT10/28	28	1	93,0	89,13	87,31	-	60,0	21,0	31,0	30,0	40,0	37,0	47,0	56,0	66,0	10,0	
PMAT quoteY AT10/30	30	1	97,0	95,49	93,67	-	60,0	21,0	31,0	30,0	40,0	37,0	47,0	56,0	66,0	10,0	
PMAT quoteY AT10/32	32	1	106,0	101,86	100,04	-	65,0	21,0	31,0	30,0	40,0	37,0	47,0	56,0	66,0	10,0	
PMAT quoteY AT10/36	36	1	119,0	114,59	112,77	-	70,0	21,0	31,0	30,0	40,0	37,0	47,0	56,0	66,0	10,0	
PMAT quoteY AT10/40	40	1	131,0	127,32	125,50	-	80,0	21,0	31,0	30,0	40,0	37,0	47,0	56,0	66,0	10,0	
PMAT quoteY AT10/44	44	3A	-	140,06	138,24	118,0	88,0	21,0	31,0	30,0	40,0	37,0	47,0	56,0	66,0	10,0	
PMAT quoteY AT10/48	48	3A	-	152,79	150,97	130,0	95,0	21,0	31,0	30,0	40,0	37,0	47,0	56,0	66,0	10,0	
PMAT quoteY AT10/60	60	3A	-	190,99	189,17	165,0	110,0	21,0	31,0	30,0	40,0	37,0	47,0	56,0	66,0	10,0	

Dimensions of timing pulleys METRIC PITCH “AT” - solid hub



AT 20

Code	Teeth nr.	Type	E [mm]	R [mm]	S [mm]	U [mm]	H [mm]	d Ø	Belt width									Material
									32 mm			50 mm			100 mm			
									W [mm]	Y [mm]	Z [mm]	W [mm]	Y [mm]	Z [mm]	W [mm]	Y [mm]	Z [mm]	
PMAT quoteY AT20/18	18	1	118,0	114,59	111,77	-	80,0	-	42,0	53,0	11,0	60,0	71,0	11,0	110,0	123,0	13,0	on request
PMAT quoteY AT20/20	20	1	134,0	127,32	124,50	-	90,0	-	42,0	53,0	11,0	60,0	71,0	11,0	110,0	123,0	13,0	
PMAT quoteY AT20/22	22	1	150,0	140,06	137,24	-	90,0	-	42,0	53,0	11,0	60,0	71,0	11,0	110,0	123,0	13,0	
PMAT quoteY AT20/24	24	1	158,0	152,79	149,97	-	95,0	-	42,0	53,0	11,0	60,0	71,0	11,0	110,0	123,0	13,0	
PMAT quoteY AT20/25	25	1	166,0	159,15	156,33	-	95,0	-	42,0	53,0	11,0	60,0	71,0	11,0	110,0	123,0	13,0	
PMAT quoteY AT20/30	30	1	200,0	190,99	188,17	-	110,0	-	42,0	53,0	11,0	60,0	71,0	11,0	110,0	123,0	13,0	
PMAT quoteY AT20/32	32	1A	-	203,72	200,90	-	110,0	-	42,0	53,0	11,0	60,0	71,0	11,0	110,0	123,0	13,0	
PMAT quoteY AT20/36	36	1A	-	229,18	226,36	-	110,0	-	42,0	53,0	11,0	60,0	71,0	11,0	110,0	123,0	13,0	
PMAT quoteY AT20/40	40	3A	-	254,65	251,83	210,0	110,0	-	42,0	53,0	11,0	60,0	71,0	11,0	110,0	123,0	13,0	
PMAT quoteY AT20/48	48	3A	-	305,58	302,76	260,0	130,0	-	42,0	53,0	11,0	60,0	71,0	11,0	110,0	123,0	13,0	
PMAT quoteY AT20/60	60	3A	-	381,97	379,15	338,0	130,0	22,0	42,0	53,0	11,0	60,0	71,0	11,0	110,0	123,0	13,0	
PMAT quoteY AT20/72	72	3A	-	458,37	455,55	415,0	140,0	22,0	42,0	53,0	11,0	60,0	71,0	11,0	110,0	123,0	13,0	

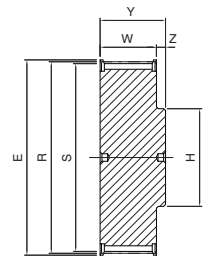

1

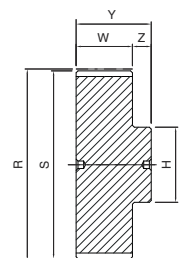

1A

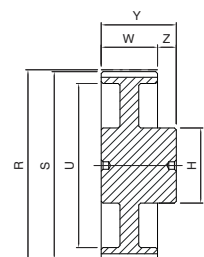

3A

Dimensions of timing pulleys EAGLE - solid hub aluminum type



Part Number	PE5M 25 -15S -MPB
EAGLE timing pulley - solid hub	
Belt width in mm	
Number of teeth	
Solid hub	

PE5M - belt width 12,5 mm

5M

Code	Teeth nr.	Type	R [mm]	S [mm]	U [mm]	H [mm]	d [mm]	W [mm]	Y [mm]	Z [mm]	Material
PE5M12,5-15S-MP	15	1	23,87	22,91	-	17,0	6,0	13,5	19,5	6,0	aluminum
PE5M12,5-16S-MP	16	1	25,47	24,51	-	19,0	6,0	13,5	19,5	6,0	
PE5M12,5-18S-MP	18	1	28,65	27,69	-	22,0	6,0	13,5	19,5	6,0	
PE5M12,5-19S-MP	19	1	30,23	29,27	-	24,0	6,0	13,5	21,5	8,0	
PE5M12,5-20S-MP	20	1	31,83	30,87	-	25,0	6,0	13,5	21,5	8,0	
PE5M12,5-22S-MP	22	1	35,01	34,05	-	28,0	6,0	13,5	21,5	8,0	
PE5M12,5-24S-MP	24	1	38,19	37,23	-	32,0	6,0	13,5	21,5	8,0	
PE5M12,5-25S-MP	25	1	39,79	38,83	-	33,0	6,0	13,5	21,5	8,0	
PE5M12,5-26S-MP	26	1	41,38	40,42	-	35,0	6,0	13,5	21,5	8,0	
PE5M12,5-27S-MP	27	1	42,97	42,01	-	36,0	6,0	13,5	21,5	8,0	
PE5M12,5-28S-MP	28	1	44,56	43,60	-	38,0	6,0	13,5	21,5	8,0	
PE5M12,5-30S-MP	30	1	47,75	46,79	-	41,0	12,7	13,5	21,5	8,0	
PE5M12,5-32S-MP	32	1	50,93	49,97	-	44,0	12,7	13,5	21,5	8,0	
PE5M12,5-36S-MP	36	1	57,30	56,34	-	51,0	12,7	13,5	21,5	8,0	
PE5M12,5-40S-MP	40	1	63,66	62,70	-	57,0	12,7	13,5	24,5	11,0	
PE5M12,5-44S-MP	44	1	70,03	69,07	-	63,0	12,7	13,5	24,5	11,0	
PE5M12,5-48S-MP	48	1	76,39	75,43	-	70,0	12,7	13,5	24,5	11,0	
PE5M12,5-60S-MP	60	1	95,49	94,53	-	89,0	12,7	13,5	24,5	11,0	

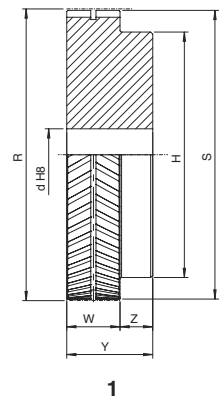

PE5M - belt width 25 mm

5M

Code	Teeth nr.	Type	R [mm]	S [mm]	U [mm]	H [mm]	d [mm]	W [mm]	Y [mm]	Z [mm]	Material
PE5M25-15S-MPB	15	1	23,87	22,91	-	17,0	6,0	26,0	32,0	6,0	aluminum
PE5M25-16S-MPB	16	1	25,47	24,51	-	19,0	6,0	26,0	32,0	6,0	
PE5M25-18S-MPB	18	1	28,65	27,69	-	22,0	6,0	26,0	32,0	6,0	
PE5M25-19S-MPB	19	1	30,23	29,27	-	24,0	6,0	26,0	34,0	8,0	
PE5M25-20S-MPB	20	1	31,83	30,87	-	25,0	6,0	26,0	34,0	8,0	
PE5M25-22S-MPB	22	1	35,01	34,05	-	28,0	6,0	26,0	34,0	8,0	
PE5M25-24S-MPB	24	1	38,19	37,23	-	32,0	6,0	26,0	34,0	8,0	
PE5M25-25S-MPB	25	1	39,79	38,83	-	33,0	6,0	26,0	34,0	8,0	
PE5M25-26S-MPB	26	1	41,38	40,42	-	35,0	6,0	26,0	34,0	8,0	
PE5M25-27S-MPB	27	1	42,97	42,01	-	36,0	6,0	26,0	34,0	8,0	
PE5M25-28S-MPB	28	1	44,56	43,60	-	38,0	6,0	26,0	34,0	8,0	
PE5M25-30S-MPB	30	1	47,75	46,79	-	41,0	12,7	26,0	34,0	8,0	
PE5M25-32S-MPB	32	1	50,93	49,97	-	44,0	12,7	26,0	34,0	8,0	
PE5M25-36S-MPB	36	1	57,30	56,34	-	51,0	12,7	26,0	34,0	8,0	
PE5M25-40S-MPB	40	1	63,66	62,70	-	57,0	12,7	26,0	37,0	11,0	
PE5M25-44S-MPB	44	1	70,03	69,07	-	63,0	12,7	26,0	37,0	11,0	
PE5M25-48S-MPB	48	1	76,39	75,43	-	70,0	12,7	26,0	37,0	11,0	
PE5M25-60S-MPB	60	1	95,49	94,53	-	89,0	12,7	26,0	37,0	11,0	

Dimensions of timing pulleys EAGLE - solid hub aluminum type



Part Number	PE	M	-20S	-MPB
EAGLE timing pulley - solid hub				
Belt width (25 mm)				
Number of teeth				
Solid hub				

PEM - belt width 25 mm

8M

Code	Teeth nr.	Type	R [mm]	S [mm]	H [mm]	d [mm]	W [mm]	Y [mm]	Z [mm]	Max bore	Material
PEM-20S-MPB	20	1	50,93	49,55	41,0	12,7	26,0	38,0	12,0	27,0	aluminum
PEM-22S-MPB	22	1	56,02	54,64	46,0	12,7	26,0	38,0	12,0	31,0	
PEM-24S-MPB	24	1	61,12	59,74	51,0	12,7	26,0	42,0	16,0	34,0	
PEM-26S-MPB	26	1	66,21	64,83	58,0	12,7	26,0	42,0	16,0	39,0	
PEM-28S-MPB	28	1	71,30	69,92	62,0	12,7	26,0	42,0	16,0	41,0	
PEM-30S-MPB	30	1	76,39	75,01	67,0	12,7	26,0	42,0	16,0	45,0	
PEM-32S-MPB	32	1	81,49	80,11	72,0	12,7	26,0	42,0	16,0	48,0	
PEM-34S-MPB	34	1	86,58	85,20	77,0	12,7	26,0	42,0	16,0	51,0	
PEM-36S-MPB	36	1	91,67	90,29	82,0	12,7	26,0	42,0	16,0	55,0	
PEM-38S-MPB	38	1	96,77	95,39	87,0	12,7	26,0	42,0	16,0	58,0	
PEM-40S-MPB	40	1	101,86	100,48	92,0	12,7	26,0	42,0	16,0	62,0	
PEM-56S-MPB	56	1	142,60	141,22	133,0	12,7	26,0	42,0	16,0	89,0	
PEM-90S-MPB	90	2	229,18	227,80	120,0	25,4	26,0	42,0	16,0	80,0	

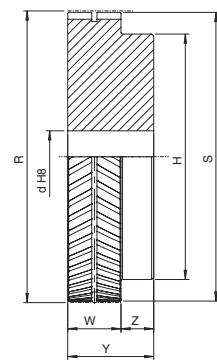

1

PEL - belt width 50 mm

8M

Code	Teeth nr.	Type	R [mm]	S [mm]	H [mm]	d [mm]	W [mm]	Y [mm]	Z [mm]	Max bore	Material
PEL-20S-MPB	20	1	50,93	49,55	41,0	12,7	51,0	63,0	12,0	27,0	aluminum
PEL-22S-MPB	22	1	56,02	54,64	46,0	12,7	51,0	63,0	12,0	31,0	
PEL-24S-MPB	24	1	61,12	59,74	51,0	12,7	51,0	67,0	16,0	34,0	
PEL-26S-MPB	26	1	66,21	64,83	58,0	12,7	51,0	67,0	16,0	39,0	
PEL-28S-MPB	28	1	71,30	69,92	62,0	12,7	51,0	67,0	16,0	41,0	
PEL-30S-MPB	30	1	76,39	75,01	67,0	12,7	51,0	67,0	16,0	45,0	
PEL-32S-MPB	32	1	81,49	80,11	72,0	12,7	51,0	67,0	16,0	48,0	
PEL-34S-MPB	34	1	86,58	85,20	77,0	12,7	51,0	67,0	16,0	51,0	
PEL-36S-MPB	36	1	91,67	90,29	82,0	12,7	51,0	67,0	16,0	55,0	
PEL-38S-MPB	38	1	96,77	95,39	87,0	12,7	51,0	67,0	16,0	58,0	
PEL-40S-MPB	40	1	101,86	100,48	92,0	12,7	51,0	67,0	16,0	62,0	
PEL-56S-MPB	56	1	142,60	141,22	133,0	12,7	51,0	67,0	16,0	89,0	
PEL-90S-MPB	90	2	229,18	227,80	120,0	25,4	51,0	67,0	16,0	80,0	

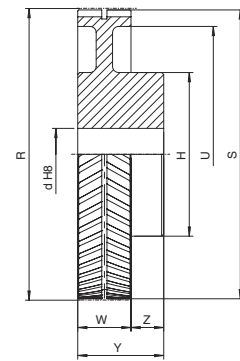

2

Dimensions of timing pulleys EAGLE - solid hub aluminum type



Part Number	PE10M 25 -15S -MPB
EAGLE timing pulley - solid hub	
Belt width (25 mm)	
Number of teeth	
Solid hub	

PE10M - belt width 25 mm

10M

Code	Teeth nr.	Type	R [mm]	S [mm]	U [mm]	H [mm]	d [mm]	W [mm]	Y [mm]	Z [mm]	Max bore [mm]	Material
PE10M25-15S-MPB	15	1	47,75	45,75	-	35,0	12,70	26,0	36,0	10,0	23,0	aluminum
PE10M25-16S-MPB	16	1	50,93	48,93	-	38,0	12,70	26,0	36,0	10,0	25,0	
PE10M25-18S-MPB	18	1	57,30	55,30	-	44,0	12,70	26,0	36,0	10,0	30,0	
PE10M25-19S-MPB	19	1	60,48	58,48	-	47,0	12,70	26,0	36,0	10,0	32,0	
PE10M25-20S-MPB	20	1	63,66	61,66	-	51,0	12,70	26,0	36,0	10,0	34,0	
PE10M25-22S-MPB	22	1	70,03	68,03	-	57,0	12,70	26,0	36,0	10,0	38,0	
PE10M25-24S-MPB	24	1	76,39	74,39	-	63,0	12,70	26,0	36,0	10,0	42,0	
PE10M25-25S-MPB	25	1	79,58	77,58	-	67,0	12,70	26,0	36,0	10,0	44,0	
PE10M25-26S-MPB	26	1	82,76	80,76	-	70,0	12,70	26,0	36,0	10,0	47,0	
PE10M25-27S-MPB	27	1	85,94	83,94	-	73,0	12,70	26,0	36,0	10,0	49,0	
PE10M25-28S-MPB	28	1	89,13	87,13	-	76,0	12,70	26,0	36,0	10,0	51,0	
PE10M25-30S-MPB	30	1	95,49	93,49	-	82,0	12,70	26,0	36,0	10,0	55,0	
PE10M25-32S-MPB	32	1	101,86	99,86	-	89,0	12,70	26,0	36,0	10,0	59,0	
PE10M25-36S-MPB	36	1	114,59	112,59	-	102,0	12,70	26,0	36,0	10,0	68,0	
PE10M25-40S-MPB	40	1	127,32	125,32	-	114,0	12,70	26,0	36,0	10,0	76,0	
PE10M25-44S-MPB	44	1	140,06	138,06	-	127,0	12,70	26,0	36,0	10,0	85,0	
PE10M25-48S-MPB	48	1	152,79	150,79	-	140,0	12,70	26,0	36,0	10,0	93,0	
PE10M25-60S-MPB	60	2	190,99	188,99	162,0	110,0	25,40	26,0	36,0	10,0	65,0	

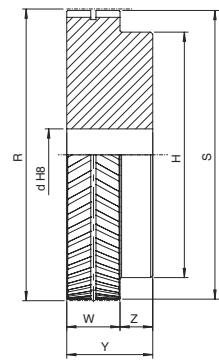

1

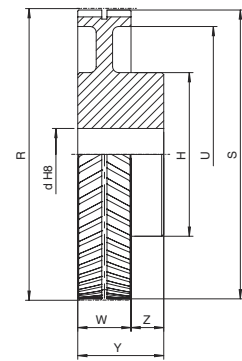

2

PE10M - belt width 32 mm

10M

Code	Teeth nr.	Type	R [mm]	S [mm]	U [mm]	H [mm]	d [mm]	W [mm]	Y [mm]	Z [mm]	Max bore [mm]	Material
PE10M32-15S-MPB	15	1	47,75	45,75	-	35,0	12,70	33,0	43,0	10,0	23,0	aluminum
PE10M32-16S-MPB	16	1	50,93	48,93	-	38,0	12,70	33,0	43,0	10,0	25,0	
PE10M32-18S-MPB	18	1	57,30	55,30	-	44,0	12,70	33,0	43,0	10,0	30,0	
PE10M32-19S-MPB	19	1	60,48	58,48	-	47,0	12,70	33,0	43,0	10,0	32,0	
PE10M32-20S-MPB	20	1	63,66	61,66	-	51,0	12,70	33,0	43,0	10,0	34,0	
PE10M32-22S-MPB	22	1	70,03	68,03	-	57,0	12,70	33,0	43,0	10,0	38,0	
PE10M32-24S-MPB	24	1	76,39	74,39	-	63,0	12,70	33,0	43,0	10,0	42,0	
PE10M32-25S-MPB	25	1	79,58	77,58	-	67,0	12,70	33,0	43,0	10,0	44,0	
PE10M32-26S-MPB	26	1	82,76	80,76	-	70,0	12,70	33,0	43,0	10,0	47,0	
PE10M32-27S-MPB	27	1	85,94	83,94	-	73,0	12,70	33,0	43,0	10,0	49,0	
PE10M32-28S-MPB	28	1	89,13	87,13	-	76,0	12,70	33,0	43,0	10,0	51,0	
PE10M32-30S-MPB	30	1	95,49	93,49	-	82,0	12,70	33,0	43,0	10,0	55,0	
PE10M32-32S-MPB	32	1	101,86	99,86	-	89,0	12,70	33,0	43,0	10,0	59,0	
PE10M32-36S-MPB	36	1	114,59	112,59	-	102,0	12,70	33,0	43,0	10,0	68,0	
PE10M32-40S-MPB	40	1	127,32	125,32	-	114,0	12,70	33,0	43,0	10,0	76,0	
PE10M32-44S-MPB	44	1	140,06	138,06	-	127,0	12,70	33,0	43,0	10,0	85,0	
PE10M32-48S-MPB	48	1	152,79	150,79	-	140,0	12,70	33,0	43,0	10,0	93,0	
PE10M32-60S-MPB	60	2	190,99	188,99	161,0	178,0	25,40	33,0	43,0	10,0	105,0	

Dimensions of timing pulleys EAGLE - solid hub aluminum type



PE10M - belt width 50 mm

10M

Code	Teeth nr.	Type	R [mm]	S [mm]	U [mm]	H [mm]	d [mm]	W [mm]	Y [mm]	Z [mm]	Max bore [mm]	Material
PE10M50-15S-MPB	15	1	47,75	45,75	-	35,0	12,70	51,0	61,0	10,0	23,0	aluminum
PE10M50-16S-MPB	16	1	50,93	48,93	-	38,0	12,70	51,0	61,0	10,0	25,0	
PE10M50-18S-MPB	18	1	57,30	55,30	-	44,0	12,70	51,0	61,0	10,0	30,0	
PE10M50-19S-MPB	19	1	60,48	58,48	-	47,0	12,70	51,0	61,0	10,0	32,0	
PE10M50-20S-MPB	20	1	63,66	61,66	-	51,0	12,70	51,0	61,0	10,0	34,0	
PE10M50-22S-MPB	22	1	70,03	68,03	-	57,0	12,70	51,0	61,0	10,0	38,0	
PE10M50-24S-MPB	24	1	76,39	74,39	-	63,0	12,70	51,0	61,0	10,0	42,0	
PE10M50-25S-MPB	25	1	79,58	77,58	-	67,0	12,70	51,0	61,0	10,0	44,0	
PE10M50-26S-MPB	26	1	82,76	80,76	-	70,0	12,70	51,0	61,0	10,0	47,0	
PE10M50-27S-MPB	27	1	85,94	83,94	-	73,0	12,70	51,0	61,0	10,0	49,0	
PE10M50-28S-MPB	28	1	89,13	87,13	-	76,0	12,70	51,0	61,0	10,0	51,0	
PE10M50-30S-MPB	30	1	95,49	93,49	-	82,0	12,70	51,0	61,0	10,0	55,0	
PE10M50-32S-MPB	32	1	101,86	99,86	-	89,0	12,70	51,0	61,0	10,0	59,0	
PE10M50-36S-MPB	36	1	114,59	112,59	-	102,0	12,70	51,0	61,0	10,0	68,0	
PE10M50-40S-MPB	40	1	127,32	125,32	-	114,0	12,70	51,0	61,0	10,0	76,0	
PE10M50-44S-MPB	44	1	140,06	138,06	-	127,0	12,70	51,0	61,0	10,0	85,0	
PE10M50-48S-MPB	48	1	152,79	150,79	-	140,0	12,70	51,0	61,0	10,0	93,0	
PE10M50-60S-MPB	60	2	190,99	188,99	161,0	178,0	25,40	51,0	61,0	10,0	105,0	

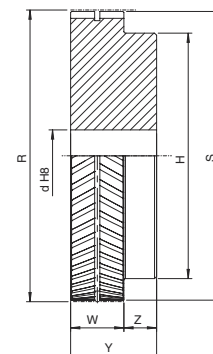

1

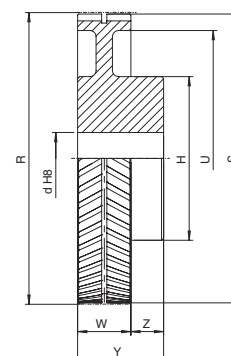

2

SIT timing bars - IMPERIAL PITCH

Pitches MXL - XL - L

“MXL” timing bars are made of 6082 aluminum suitable for hard anodizing treatment.

“XL” and “L” timing bars are made of C45 steel and of 6082 aluminum suitable for hard anodizing treatment.

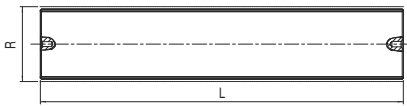

1

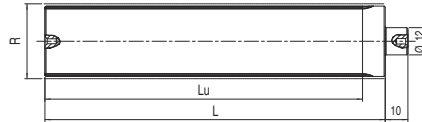

3

Dimensions

MXL 0,080" (2,032 mm)					
ALUMINUM					
Code	Teeth nr.	Type	R [mm]	Lu [mm]	L [mm]
BAR10MXL*	10	3	6,47	50	75
BAR11MXL*	11	3	7,11	50	75
BAR12MXL	12	3	7,76	50	75
BAR13MXL*	13	3	8,41	50	75
BAR14MXL	14	3	9,06	50	75
BAR15MXL	15	3	9,70	50	75
BAR16MXL	16	3	10,35	50	75
BAR17MXL*	17	3	11,00	50	75
BAR18MXL	18	3	11,64	50	75
BAR19MXL*	19	3	12,29	90	120
BAR20MXL	20	3	12,94	90	120
BAR21MXL*	21	3	13,58	90	120
BAR22MXL	22	3	14,23	125	140
BAR23MXL*	23	3	14,88	125	140
BAR24MXL	24	3	15,52	125	140
BAR25MXL	25	3	16,17	125	140
BAR26MXL	26	3	16,82	125	140
BAR27MXL*	27	3	17,46	125	140
BAR28MXL	28	3	18,11	125	140
BAR29MXL*	29	3	18,76	125	140
BAR30MXL	30	3	19,40	125	140
BAR32MXL	32	3	20,70	125	140
BAR34MXL	34	3	21,99	125	140
BAR35MXL*	35	3	22,64	132	140
BAR36MXL	36	3	23,29	132	140
BAR38MXL	38	3	24,58	132	140
BAR40MXL	40	3	25,87	132	140
BAR42MXL	42	3	27,17	140	140
BAR44MXL	44	3	28,46	140	140
BAR45MXL	45	3	29,11	140	140
BAR48MXL	48	3	31,05	140	140
BAR50MXL*	50	3	32,34	140	140
BAR60MXL	60	3	38,81	160	160
BAR64MXL*	64	3	41,40	160	160
BAR65MXL*	65	3	42,04	160	160
BAR70MXL	70	3	45,28	160	160
BAR72MXL	72	3	46,57	160	160
BAR75MXL*	75	3	48,51	160	160
BAR90MXL*	90	3	58,21	160	160
BAR110MXL*	110	3	71,15	160	160

XL 1/5" (5,08 mm)					
STEEL - ALUMINUM					
Code	Teeth nr.	Type	R [mm]	Lu [mm]	L [mm]
BAR10XL	10	1	16,17	140	140
BAR11XL	11	1	17,79	140	140
BAR12XL	12	1	19,4	140	140
BAR13XL	13	1	21,02	140	140
BAR14XL	14	1	22,64	140	140
BAR15XL	15	1	24,25	140	140
BAR16XL	16	1	25,87	140	140
BAR17XL	17	1	27,49	140	140
BAR18XL	18	1	29,11	140	140
BAR19XL	19	1	30,72	140	140
BAR20XL	20	1	32,34	140	140
BAR21XL	21	1	33,96	160	160
BAR22XL	22	1	35,57	160	160
BAR23XL	23	1	37,19	160	160
BAR24XL	24	1	38,81	160	160
BAR25XL	25	1	40,43	160	160
BAR26XL	26	1	42,04	160	160
BAR27XL	27	1	43,66	160	160
BAR28XL	28	1	45,28	160	160
BAR29XL	29	1	46,89	160	160
BAR30XL	30	1	48,51	160	160
BAR32XL	32	1	51,74	160	160
BAR33XL	33	1	53,36	160	160
BAR34XL	34	1	54,98	160	160
BAR35XL	35	1	56,6	160	160
BAR36XL	36	1	58,21	160	160
BAR38XL	38	1	61,45	160	160
BAR39XL	39	1	63,06	160	160
BAR40XL	40	1	64,68	160	160
BAR41XL	41	1	66,3	160	160
BAR42XL	42	1	67,91	160	160
BAR43XL	43	1	69,53	160	160
BAR44XL	44	1	71,15	160	160
BAR48XL	48	1	77,62	160	160
BAR56XL	56	1	90,55	160	160
BAR60XL	60	1	97,02	160	160
BAR72XL	72	1	116,43	160	160

L 3/8" (9,525 mm)					
STEEL - ALUMINUM					
Code	Teeth nr.	Type	R [mm]	Lu [mm]	L [mm]
BAR10L	10	1	30,32	140	140
BAR11L	11	1	33,35	140	140
BAR12L	12	1	36,38	160	160
BAR13L	13	1	39,41	160	160
BAR14L	14	1	42,45	160	160
BAR15L	15	1	45,48	160	160
BAR16L	16	1	48,51	160	160
BAR17L	17	1	51,54	160	160
BAR18L	18	1	54,57	160	160
BAR19L	19	1	57,61	160	160
BAR20L	20	1	60,64	160	160
BAR21L	21	1	63,67	160	160
BAR22L	22	1	66,7	160	160
BAR23L	23	1	69,73	160	160
BAR24L	24	1	72,77	160	160
BAR27L	27	1	81,86	160	160
BAR30L	30	1	90,96	160	160

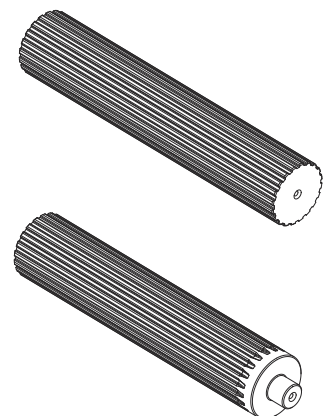

1

3

Part Number **BAR 40 XL / AC**

Timing Bar _____

Teeth number _____

Pitch _____

Material - AC: steel; AL: aluminum _____

*= available on demand

Pitches 3M - 5M - 8M

“TOP DRIVE® HTD” timing bars are made of 6082 aluminum suitable for hard anodizing treatment.

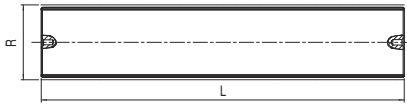

1

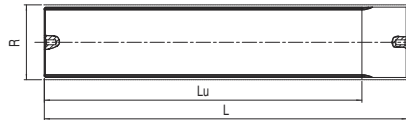

2

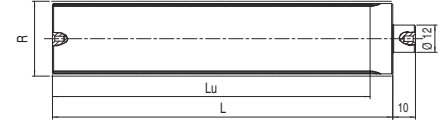

3

Dimensions

HTD 3M pitch 3 mm					
ALUMINUM					
Code	Teeth nr.	Type	R [mm]	Lu [mm]	L [mm]
BAR9-3M*	9	3	8,59	75	100
BAR10-3M	10	3	9,55	75	100
BAR11-3M*	11	3	10,50	75	100
BAR12-3M	12	3	11,46	100	125
BAR13-3M*	13	3	12,41	100	125
BAR14-3M	14	3	13,37	100	125
BAR15-3M	15	3	14,32	100	125
BAR16-3M	16	3	15,28	125	155
BAR17-3M*	17	3	16,23	125	155
BAR18-3M	18	3	17,19	125	155
BAR19-3M*	19	3	18,14	125	155
BAR20-3M	20	3	19,10	150	165
BAR21-3M	21	3	20,05	150	165
BAR22-3M	22	3	21,01	150	165
BAR23-3M*	23	3	21,96	150	165
BAR24-3M	24	3	22,92	150	165
BAR25-3M*	25	3	23,87	150	165
BAR26-3M	26	3	24,83	150	165
BAR27-3M*	27	3	25,78	150	165
BAR28-3M	28	3	26,74	150	165
BAR29-3M*	29	3	27,69	150	165
BAR30-3M	30	3	28,65	175	183
BAR31-3M*	31	3	29,60	175	183
BAR32-3M	32	3	30,56	175	183
BAR33-3M*	33	3	31,51	175	183
BAR34-3M	34	3	32,47	175	183
BAR35-3M*	35	3	33,42	175	183
BAR36-3M	36	3	34,38	200	200
BAR37-3M*	37	3	35,33	200	200
BAR38-3M	38	3	36,29	200	200
BAR39-3M*	39	3	37,24	200	200
BAR40-3M	40	3	38,20	200	200
BAR42-3M*	42	3	40,11	200	200
BAR44-3M	44	3	42,02	200	200
BAR45-3M*	45	3	42,97	200	200
BAR48-3M	48	3	45,84	200	200
BAR50-3M*	50	3	47,75	200	200
BAR52-3M*	52	3	49,66	200	200
BAR54-3M*	54	3	51,57	200	200
BAR56-3M*	56	3	53,48	200	200
BAR60-3M	60	3	57,30	200	200
BAR62-3M*	62	3	59,21	200	200
BAR64-3M*	64	3	61,12	200	200
BAR66-3M*	66	3	63,03	200	200
BAR68-3M*	68	3	64,94	200	200
BAR70-3M*	70	3	66,85	200	200
BAR72-3M*	72	3	68,75	200	200

HTD 5M pitch 5 mm					
ALUMINUM					
Code	Teeth nr.	Type	R [mm]	Lu [mm]	L [mm]
BAR12-5M	12	2	19,10	150	165
BAR13-5M	13	2	20,69	150	165
BAR14-5M	14	2	22,28	175	183
BAR15-5M	15	2	23,87	175	183
BAR16-5M	16	2	25,46	175	183
BAR17-5M	17	2	27,06	175	183
BAR18-5M	18	1	28,65	200	200
BAR19-5M	19	1	30,24	200	200
BAR20-5M	20	1	31,83	200	200
BAR21-5M	21	1	33,42	200	200
BAR22-5M	22	1	35,01	200	200
BAR23-5M	23	1	36,61	200	200
BAR24-5M	24	1	38,20	200	200
BAR25-5M	25	1	39,79	200	200
BAR26-5M	26	1	41,38	200	200
BAR27-5M	27	1	42,97	200	200
BAR28-5M	28	1	44,56	200	200
BAR29-5M	29	1	46,15	200	200
BAR30-5M	30	1	47,75	200	200
BAR31-5M	31	1	49,34	200	200
BAR32-5M	32	1	50,93	200	200
BAR33-5M	33	1	52,52	200	200
BAR34-5M	34	1	54,11	200	200
BAR35-5M	35	1	55,70	200	200
BAR36-5M	36	1	57,30	200	200
BAR38-5M	38	1	60,48	200	200
BAR40-5M	40	1	63,66	200	200
BAR42-5M	42	1	66,85	200	200
BAR44-5M	44	1	70,03	200	200
BAR45-5M	45	1	71,62	200	200
BAR46-5M	46	1	73,21	200	200
BAR48-5M	48	1	76,39	200	200
BAR50-5M	50	1	79,58	200	200
BAR54-5M	54	1	85,94	200	200
BAR60-5M	60	1	95,49	200	200
BAR62-5M	62	1	98,68	200	200
BAR72-5M	72	1	114,59	200	200

HTD 8M pitch 8 mm					
ALUMINUM					
Code	Teeth nr.	Type	R [mm]	Lu [mm]	L [mm]
BAR18-8M	18	1	45,84	200	200
BAR19-8M	19	1	48,38	200	200
BAR20-8M	20	1	50,93	200	200
BAR21-8M	21	1	53,48	200	200
BAR22-8M	22	1	56,02	200	200
BAR23-8M	23	1	58,57	200	200
BAR24-8M	24	1	61,12	200	200
BAR25-8M	25	1	63,66	200	200
BAR26-8M	26	1	66,21	200	200
BAR28-8M	28	1	71,30	200	200
BAR30-8M	30	1	76,39	200	200
BAR32-8M	32	1	81,49	200	200
BAR34-8M	34	1	86,58	200	200
BAR35-8M	35	1	89,13	200	200
BAR36-8M	36	1	91,67	200	200
BAR38-8M	38	1	96,77	200	200
BAR40-8M	40	1	101,86	200	200
BAR44-8M	44	1	112,05	200	200
BAR48-8M	48	1	122,23	200	200

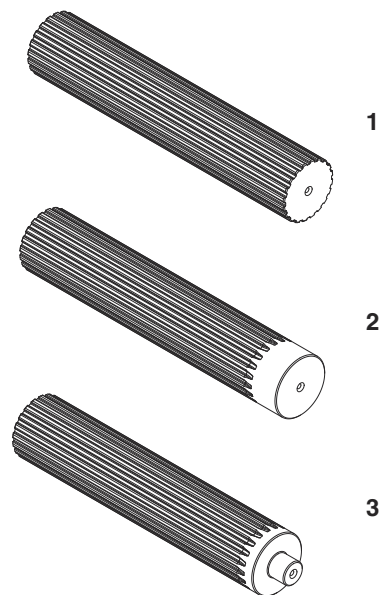

Part Number **BAR 25 - 5M / AL**

Timing Bar _____

Teeth number _____

Pitch _____

Material - AL: aluminum

*= available on demand

SIT timing bars - METRIC PITCH

Pitches T 2,5 - T 5 - T 10

"T" timing bars are made of 6082 aluminum suitable for hard anodizing treatment.

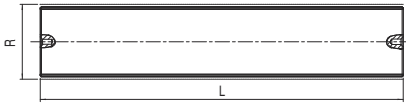

1

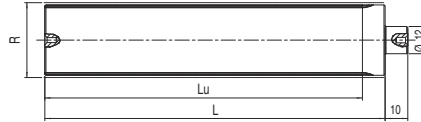

3

Dimensions

T 2,5 pitch 2,5 mm					
ALUMINUM					
Code	Teeth nr.	Type	R [mm]	Lu [mm]	L [mm]
BAR10T2,5	10	3	7,96	50	75
BAR12T2,5	12	3	9,55	50	75
BAR13T2,5	13	3	10,35	50	75
BAR14T2,5	14	3	11,14	50	75
BAR15T2,5	15	3	11,94	50	75
BAR16T2,5	16	3	12,73	50	75
BAR17T2,5	17	3	13,53	50	75
BAR18T2,5	18	3	14,32	50	75
BAR19T2,5	19	3	15,12	90	120
BAR20T2,5	20	3	15,92	90	120
BAR21T2,5	21	3	16,71	90	120
BAR22T2,5	22	3	17,51	125	140
BAR24T2,5	24	3	19,10	125	140
BAR26T2,5	26	3	20,69	125	140
BAR27T2,5	27	3	21,49	125	140
BAR28T2,5	28	3	22,28	125	140
BAR29T2,5	29	3	23,08	125	140
BAR30T2,5	30	3	23,87	125	140
BAR32T2,5	32	3	25,46	125	140
BAR34T2,5	34	3	27,06	125	140
BAR35T2,5	35	3	27,85	132	140
BAR36T2,5	36	3	28,65	132	140
BAR38T2,5	38	3	30,24	132	140
BAR40T2,5	40	3	31,83	132	140
BAR42T2,5	42	3	33,42	140	140
BAR44T2,5	44	3	35,01	140	140
BAR45T2,5	45	3	35,81	140	140
BAR48T2,5	48	3	38,20	140	140
BAR50T2,5	50	3	39,79	160	160
BAR60T2,5	60	3	47,75	160	160
BAR65T2,5	65	3	51,73	160	160
BAR70T2,5	70	3	55,70	160	160
BAR72T2,5	72	3	57,30	160	160
BAR90T2,5	90	3	71,62	160	160
BAR100T2,5	100	3	79,58	160	160

T 5 pitch 5 mm					
ALUMINUM					
Code	Teeth nr.	Type	R [mm]	Lu [mm]	L [mm]
BAR10T5	10	1	15,91	140	140
BAR11T5	11	1	17,5	140	140
BAR12T5	12	1	19,1	140	140
BAR13T5	13	1	20,69	140	140
BAR14T5	14	1	22,28	140	140
BAR15T5	15	1	23,87	140	140
BAR16T5	16	1	25,47	140	140
BAR17T5	17	1	27,06	140	140
BAR18T5	18	1	28,65	140	140
BAR19T5	19	1	30,24	140	140
BAR20T5	20	1	31,83	160	160
BAR21T5	21	1	33,42	160	160
BAR22T5	22	1	35,01	160	160
BAR23T5	23	1	36,61	160	160
BAR24T5	24	1	38,19	160	160
BAR25T5	25	1	39,79	160	160
BAR26T5	26	1	41,38	160	160
BAR27T5	27	1	42,97	160	160
BAR28T5	28	1	44,56	160	160
BAR29T5	29	1	46,16	160	160
BAR30T5	30	1	47,15	160	160
BAR32T5	32	1	50,93	160	160
BAR34T5	34	1	54,11	160	160
BAR35T5	35	1	55,71	160	160
BAR36T5	36	1	57,3	160	160
BAR37T5	37	1	58,89	160	160
BAR38T5	38	1	60,48	160	160
BAR40T5	40	1	63,66	160	160
BAR42T5	42	1	68,85	160	160
BAR44T5	44	1	70,03	160	160
BAR45T5	45	1	71,62	160	160
BAR46T5	46	1	73,21	160	160
BAR48T5	48	1	76,39	160	160
BAR50T5	50	1	79,58	160	160
BAR60T5	60	1	95,49	160	160
BAR72T5	72	1	114,59	160	160
BAR80T5	80	1	127,32	160	160
BAR90T5	90	1	143,24	160	160
BAR100T5	100	1	159,15	160	160

T 10 pitch 10 mm					
ALUMINUM					
Code	Teeth nr.	Type	R [mm]	Lu [mm]	L [mm]
BAR10T10	10	1	31,83	140	140
BAR11T10	11	1	35,01	140	140
BAR12T10	12	1	38,19	140	140
BAR13T10	13	1	41,38	140	140
BAR14T10	14	1	44,56	160	160
BAR15T10	15	1	47,74	160	160
BAR16T10	16	1	50,93	160	160
BAR17T10	17	1	54,11	160	160
BAR18T10	18	1	57,29	160	160
BAR19T10	19	1	60,47	160	160
BAR20T10	20	1	63,66	160	160
BAR21T10	21	1	66,84	160	160
BAR22T10	22	1	70,02	160	160
BAR23T10	23	1	73,21	160	160
BAR24T10	24	1	76,39	160	160
BAR26T10	26	1	82,76	160	160
BAR28T10	28	1	89,12	160	160
BAR30T10	30	1	95,49	160	160
BAR32T10	32	1	101,85	160	160
BAR34T10	34	1	108,22	160	160
BAR36T10	36	1	114,59	160	160
BAR38T10	38	1	120,95	160	160
BAR40T10	40	1	127,32	160	160
BAR45T10	45	1	143,23	160	160
BAR48T10	48	1	152,78	160	160
BAR60T10	60	1	190,98	160	160
BAR72T10	72	1	229,17	160	160

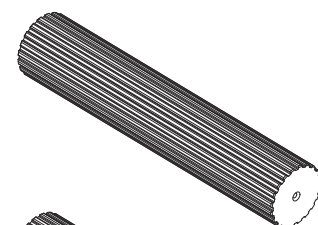

1

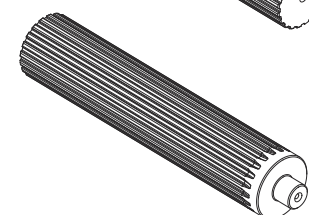

3

Part Number **BAR 22 T10 / AL**

Timing Bar _____

Teeth number _____

Pitch _____

Material - AL: aluminum _____

Pitches AT 5 - AT 10

“AT” timing bars are made of 6082 aluminum suitable for hard anodizing treatment.

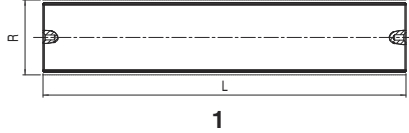

Part Number **BAR 28 AT10 / AL**

Timing Bar

Teeth number

Pitch

Material - AL: aluminum

Dimensions

AT 5 pitch 5 mm					
ALUMINUM					
Code	Teeth nr.	Type	R [mm]	Lu [mm]	L [mm]
BAR12AT5	12	1	19,1	140	140
BAR13AT5	13	1	20,69	140	140
BAR14AT5	14	1	22,28	140	140
BAR15AT5	15	1	23,87	140	140
BAR16AT5	16	1	25,47	140	140
BAR17AT5	17	1	27,06	140	140
BAR18AT5	18	1	28,65	140	140
BAR19AT5	19	1	30,24	140	140
BAR20AT5	20	1	31,83	160	160
BAR21AT5	21	1	33,42	160	160
BAR22AT5	22	1	35,01	160	160
BAR23AT5	23	1	36,61	160	160
BAR24AT5	24	1	38,19	160	160
BAR25AT5	25	1	39,79	160	160
BAR26AT5	26	1	41,38	160	160
BAR27AT5	27	1	42,97	160	160
BAR28AT5	28	1	44,56	160	160
BAR29AT5	29	1	46,16	160	160
BAR30AT5	30	1	47,75	160	160
BAR31AT5	31	1	49,34	160	160
BAR32AT5	32	1	50,93	160	160
BAR33AT5	33	1	52,52	160	160
BAR34AT5	34	1	54,11	160	160
BAR35AT5	35	1	55,71	160	160
BAR36AT5	36	1	57,3	160	160
BAR38AT5	38	1	60,48	160	160
BAR40AT5	40	1	63,66	160	160
BAR42AT5	42	1	68,85	160	160
BAR44AT5	44	1	70,03	160	160
BAR45AT5	45	1	71,62	160	160
BAR46AT5	46	1	73,21	160	160
BAR48AT5	48	1	76,39	160	160
BAR50AT5	50	1	79,58	160	160
BAR52AT5	52	1	82,76	160	160
BAR54AT5	54	1	85,94	160	160
BAR55AT5	55	1	87,54	160	160
BAR56AT5	56	1	89,13	160	160
BAR58AT5	58	1	92,31	160	160
BAR60AT5	60	1	95,49	160	160
BAR62AT5	62	1	98,68	160	160
BAR64AT5	64	1	101,86	160	160
BAR65AT5	65	1	103,45	160	160
BAR70AT5	70	1	111,41	160	160
BAR72AT5	72	1	114,59	160	160

AT 10 pitch 10 mm					
ALUMINUM					
Code	Teeth nr.	Type	R [mm]	Lu [mm]	L [mm]
BAR14AT10	14	1	44,56	160	160
BAR15AT10	15	1	47,75	160	160
BAR16AT10	16	1	50,93	160	160
BAR17AT10	17	1	54,11	160	160
BAR18AT10	18	1	57,30	160	160
BAR19AT10	19	1	60,48	160	160
BAR20AT10	20	1	63,66	160	160
BAR21AT10	21	1	66,85	160	160
BAR22AT10	22	1	70,03	160	160
BAR23AT10	23	1	73,21	160	160
BAR24AT10	24	1	76,39	160	160
BAR25AT10	25	1	79,58	160	160
BAR26AT10	26	1	82,76	160	160
BAR27AT10	27	1	85,94	160	160
BAR28AT10	28	1	89,13	160	160
BAR29AT10	29	1	92,31	160	160
BAR30AT10	30	1	95,49	160	160
BAR31AT10	31	1	98,68	160	160
BAR32AT10	32	1	101,86	160	160
BAR33AT10	33	1	105,04	160	160
BAR34AT10	34	1	108,23	160	160
BAR35AT10	35	1	111,41	160	160
BAR36AT10	36	1	114,59	160	160
BAR37AT10	37	1	117,77	160	160
BAR38AT10	38	1	120,96	160	160
BAR40AT10	40	1	127,32	160	160
BAR41AT10	41	1	130,51	160	160
BAR42AT10	42	1	133,69	160	160
BAR44AT10	44	1	140,06	160	160
BAR45AT10	45	1	143,24	160	160
BAR46AT10	46	1	146,42	160	160
BAR48AT10	48	1	152,79	160	160
BAR50AT10	50	1	159,15	160	160
BAR51AT10	51	1	162,34	160	160
BAR52AT10	52	1	165,52	160	160
BAR54AT10	54	1	171,89	160	160
BAR55AT10	55	1	175,07	160	160
BAR56AT10	56	1	178,25	160	160
BAR57AT10	57	1	181,44	160	160
BAR58AT10	58	1	184,62	160	160
BAR59AT10	59	1	187,80	160	160
BAR60AT10	60	1	190,99	160	160
BAR62AT10	62	1	197,35	160	160
BAR70AT10	70	1	222,82	160	160

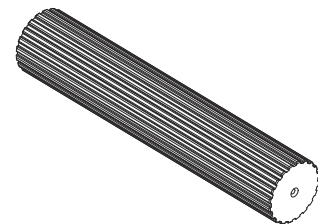

1