

# Hose assembly Handling guide

## Special care for installation of hose assemblies.

### Incorrect



Never use hose unsupported

### Correct

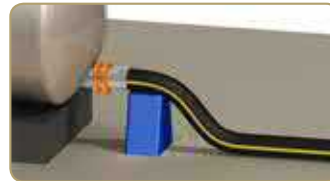

Always support hose near coupling

### Incorrect

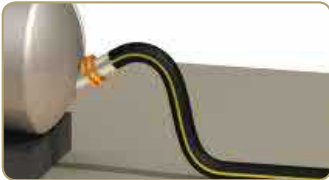

### Correct

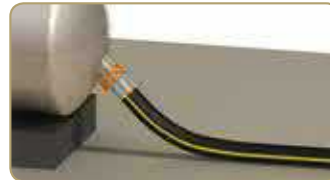

### Incorrect



Protect against sharp edges, quay edges. Ship's guard rail etc.

### Correct

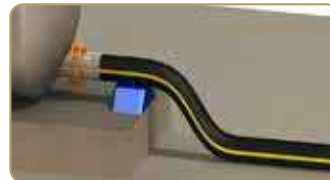

Acceptable

### Incorrect



Never use hose unsupported

### Correct

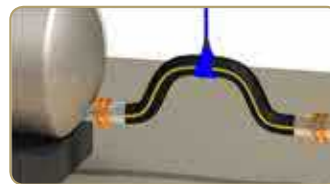

Support hose with slings where appropriate

### Incorrect



Never support hose with single rope

### Correct



Support hose with slings

### Incorrect



Never overbend hose or allow hose to hang between quay and ship

# Hose assembly Handling guide

Special care for installation of hose assemblies.

**Incorrect**



**Correct**



**Incorrect**



**Correct**



**Incorrect**



**Correct**



**Incorrect**



**Correct**



# Hose assembly Handling guide

Special care for installation of hose assemblies.

**Incorrect**



**Correct**



**Incorrect**



**Correct**



**Incorrect**



**Correct**



**Incorrect**



**Correct**



# Hose assembly Handling guide

Special care for installation of hose assemblies (diameter above 100 mm).

**Incorrect**



**Correct**

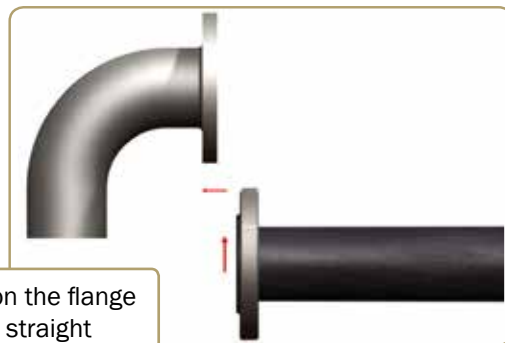

Always position the flange with hose straight



Special care for END-FLEX ends.



**CORRECT on flat-face flanges**

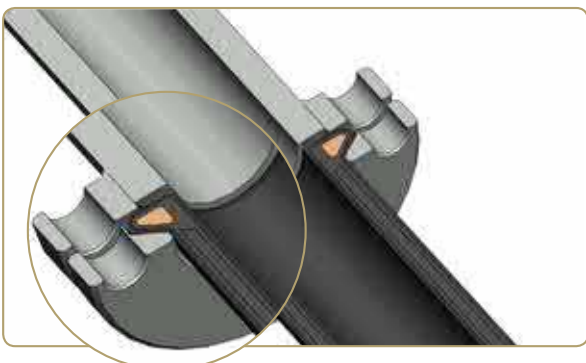

**INCORRECT on raised-face flanges**



**CORRECT on raised-face flanges with carbon fibre gasket**

# Hose assembly Handling guide

Special care for installation of hose assemblies (diameter above 100 mm).

**Incorrect**



**Correct**



**Incorrect**



**Correct**



For transportation, installations or support in place,  
never use a single rope to lift hose.  
Only slings in sufficient numbers depending of the hose lengths.

For handling in straight length, a lifting beam must be used imperatively.

We recommend the use of slings (150 mm wide minimum).

Number of slings should be at least:

- 2 for length < 6 m
- 3 for length of 6 to 8 m
- 4 for length > 8 m

**Correct**



# Storage guidelines for hoses and hose assemblies

## The sensitivity of rubber to elements such as:

- ★Oxygen
- ★Ozone
- ★Infrared Rays
- ★Ultraviolet rays
- ★Heat

requires storage to follow some simple rules in order to protect the product against accelerated aging.

## The following guidelines are in accordance with the standard ISO8331-2016:

### Rubber, composite and plastic hoses and hose assemblies guidelines for selection, storage, use and maintenance.

#### Storage room

- ▶▶ The room where the product is stored should be cool, dry, dust free and ventilated but without drafts.

#### Storage time

- ▶▶ The storage time should be minimized. FIFO management (first in - first out) is highly recommended.

#### Temperature

- ▶▶ The temperature should be as stable as possible and preferably between -10° C and +25° C.
- ▶▶ Below -10° C, caution should be taken when handling the product because it can become very rigid.

#### Heating

- ▶▶ The hoses and hose assemblies must be kept at least 2 meter away from any heat source.

#### Humidity

- ▶▶ The relative humidity should be below 70%.

#### Light

- ▶▶ Items should be stored in a dark place, and protected from sunlight or any artificial light. (UV and IR).

#### Ozone

- ▶▶ The storage room must not contain ozone-producing equipments, such as lamps or mercury vapor tubes, high voltage electrical equipment, electric motors, etc ...

#### Environment

- ▶▶ Solvents, fuels, lubricants, chemicals should not be kept in the same room as hoses.

#### Method of storage

- ▶▶ Hoses and hose assemblies must lie unconstrained and piling shall be limited whenever possible.
- ▶▶ The original packaging must be kept on as long as possible, including caps protecting the ends of the hoses.