

# Hose assembly Handling guide

**Special care for installation of hose assemblies.**

**Incorrect**

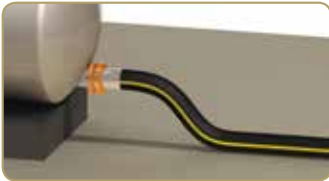

Never use hose unsupported

**Correct**

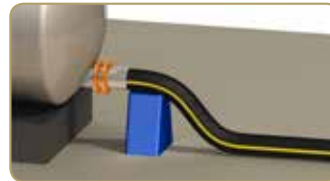

Always support hose near coupling

**Incorrect**

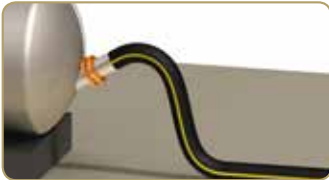

**Correct**

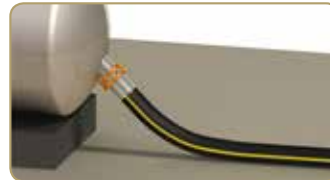

**Incorrect**

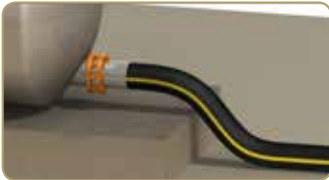

Protect against sharp edges, quay edges. Ship's guard rail etc.

**Correct**

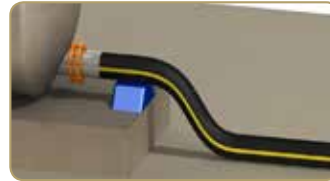

Acceptable

**Incorrect**



Never use hose unsupported

**Correct**

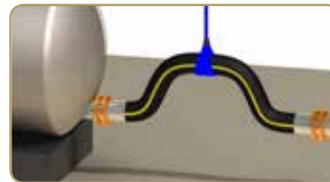

Support hose with slings where appropriate

**Incorrect**

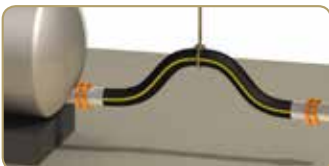

Never support hose with single rope

**Correct**

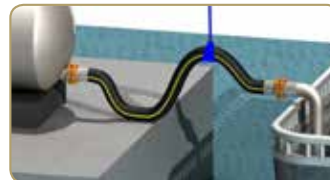

Support hose with slings

**Incorrect**



Never overbend hose or allow hose to hang between quay and ship

# Hose assembly Handling guide

Special care for installation of hose assemblies.

**Incorrect**



**Correct**



**Incorrect**



**Correct**



**Incorrect**



**Correct**



**Incorrect**



**Correct**



# Hose assembly Handling guide

Special care for installation of hose assemblies.

**Incorrect**



**Correct**



**Incorrect**



**Correct**



**Incorrect**



**Correct**



**Incorrect**



**Correct**



# Hose assembly Handling guide

Special care for installation of hose assemblies (diameter above 100 mm).

**Incorrect**



**Correct**

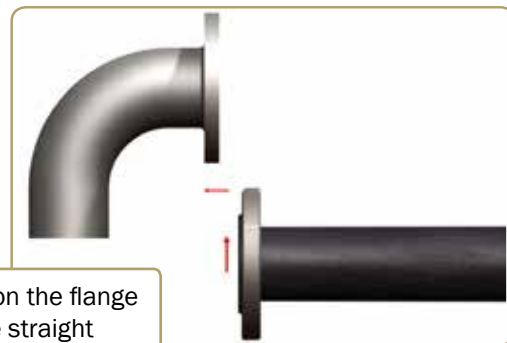

Always position the flange with hose straight



Special care for END-FLEX ends.



**CORRECT on flat-face flanges**

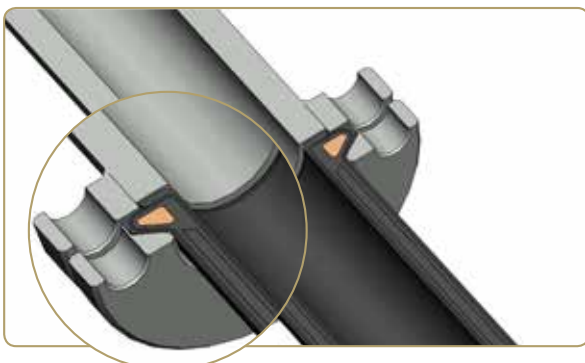

**INCORRECT on raised-face flanges**

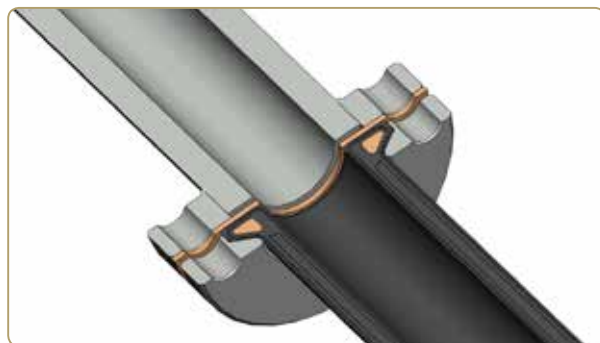

**CORRECT on raised-face flanges with carbon fibre gasket**

# Hose assembly

## Handling guide

2015

Special care for installation of hose assemblies (diameter above 100 mm).

**Incorrect**



**Correct**



**Incorrect**



**Correct**



For transportation, installations or support in place,  
never use a single rope to lift hose.  
Only slings in sufficient numbers depending of the hose lengths.

For handling in straight length, a lifting beam must be used imperatively.

We recommend the use of slings (150 mm wide minimum).

Number of slings should be at least:

- 2 for length < 6 m
- 3 for length of 6 to 8 m
- 4 for length > 8 m

**Correct**

